



HANDLING AND CONTROL MANUAL DFRA SERIES

MMCSA-EN-19-2

In compliance with the European Union regulations on the Safety of Machines,
you must read these instructions carefully before installing the equipment.

Contents

1.	Introduction.	4
2.	DFRA operating instructions.....	5
3.	Control panel and navigation keyboard of the PLR.	7
4.	Modes of operation	8
4.1	Manual mode.....	8
4.2	Automatic mode.....	8
4.3	Control of additional batteries	11
5.	Initial state.....	12
5.1	Configuration menu.....	13
5.2	Adjustments menu	16
6.	Commissioning.....	17
6.1	Manual mode selection.....	17
6.2	Automatic mode selection.....	17
6.3	Shutdown	18
6.4	Emergency stop.....	18
7.	Supervision menu	19
8.	Information menu.....	21
9.	List of alerts.	21
10.	PLR connections status.....	23

1. Introduction.

The FISAIR DFRA series dehumidifiers have moving operating parts, such as two fan motors (supply and reactivation) and a gear motor driving the desiccant wheel; and variable static operating parts, such as air heaters/coolers, filters and flow control devices.



The integration of the programmable logic relay MFD-TITAN in the dehumidifier management and operational supervision provides faster, simpler, more accurate and more reliable operation of the dehumidifier, while reducing electrical panel accessories.

The MFD-TITAN PLR controlling this type of equipment is a programmable device for the configuration, setting and monitoring of the different equipment components connected in real time. The equipment is operated from its own display or from a remote device.

The Electrical Diagram should be kept along with this manual

The automatic program is designed so that the execution, actions and/or reactions produced by the machine and its surroundings do not affect the level of safety and functionality the machine is built for, while also observing the electromagnetic compatibility directive.

Any removal and/or modification of the program contained in the PLR, operated from its own display or an online PC, will modify the guarantee conditions, as well as compliance with the directives and explicit rules covering its manufacture. The installer, handler or user will then be responsible for the repercussions of the changed functionality of the device.

The programmed device does not interfere with safety against personal injury; the following examples of passive safety components are installed for this purpose:

Grills, covers and insulation. Thus, in an extreme case of malfunction, the machine must be switched off from the mains connection via I1 and Technical Services informed.

2. DFRA operating instructions

- a) Flow control or motor fan process air pressure control.
- b) Remote ON/OFF of fan motors.
- c) Remote ON/OFF drive gear motor of the desiccant wheel.
- d) Reactivation battery RB control. Regulating the reactivation battery RB controls the equipment drying capacity (see installation and maintenance manual).
 - Manual mode, at 100% power.
 - Automatic mode:
 - Configuration by "S" stages via two external digital signals.
 - Proportional configuration "P" via a 0..10V DC analogue signal from an external regulator.
 - Configuration by measurement signal "M". By means of a humidity probe SH1 (0..10V DC).
- e) Pre-heating battery control BC1:
 - Modo Manual o Automático. Mediante la sonda de temperatura ST0 (0..10Vcc).
- f) Pre-cooling battery control BF1:
 - Manual or Automatic mode. Via the temperature probe ST3 (0-10V DC) installed in the BF1.
- g) Post-cooling battery BF2 and post-heating battery BC2 control:
 - Manual or Automatic mode, depending on the chosen configuration:
 - Proportional configuration "P". Via an analogue signal 0-10V DC, from an external regulator.
 - Configuration by measurement signal "M". By means of a
 - temperature probe ST4 (0-10V DC).

h) Measurement and supervision:

- Temperature of the reactivation air measured by the probe (ST1).
- Process air temperature measured by the probe (ST0) after the pre-heating battery BC1.

- Process air temperature measured by the probe (ST3) after the pre-cooling battery BF1.
- Process air temperature measured by the probe (ST4) after the post-cooling battery BF2.
- Process air temperature measured by the probe (ST4) after the post-heating battery BC2.
- Synopsis of component operation screen.
- Monitoring the proportional modulation of the BR (power delivered by the reactivation battery BR).
- Monitoring the power delivered by the pre-heating battery BC1.
- Monitoring the power delivered by the pre-cooling battery BF1.
- Monitoring the power delivered by the post-cooling battery BF2.
- Monitoring the power delivered by the post-heating battery BC2.
- Humidity measurements (relative, absolute, dew point or mixing ratio) and temperature measured by the probe SH1-ST2 to be installed in the process air inlet or return.
- Humidity and temperature measurements by the probe SH2-ST4 to be installed in the dry air supply.
- Monitoring humidity set point.
- Monitoring maximum humidity alarm set point.
- Minimum reactivation air flow of and rotor rotation.

i) Safety and alarms:

- Timing at the disconnection of the humid-air motor fan and the gearmotor for cooling the equipment.
- Alarm and equipment shutdown due to lack of air in the reactivation.
- Alarm and equipment shutdown due to lack of rotation of the desiccant rotor.
- Alarm and equipment shutdown due to triggering any motor thermal cut-off.
- Alarm and equipment shutdown due to triggering electrical protective devices of the heaters.
- Alarm and heater shutdown due to excessive SSR temperature.
- Alarm for blocked process and reactivation filters (if applicable).
- Alarm and BR heater shutdown due to excessive reactivation temperature as measured by probe ST1.
- BC2 heater shutdown due to excessive temperature as measured by operating thermostat TF3. To be reset manually.



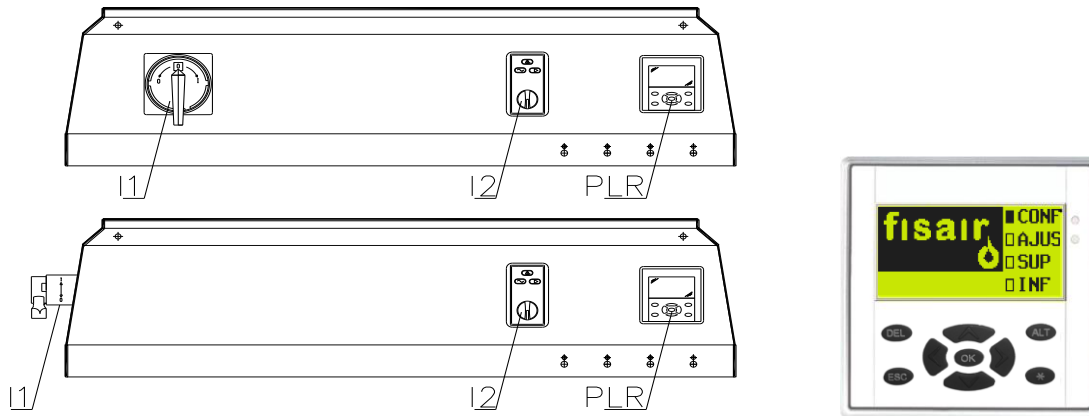



3. Control panel and navigation keyboard of the PLR.



I1. Break switch.

I2. MANual / 0 / AUTomatic selection switch

PLR. Programmable logic relay with LCD backlit black-and-white screen measuring 63x32mm and a navigation keyboard with the following functions:

KEY	OPERATION/DESCRIPTION
	Function that will depend on the particular configuration. Where applicable, this will be explained in the relevant section. The screen brightness can be increased from the start display.
	Function that will depend on the particular configuration. Where applicable, this will be explained in the relevant section. The screen brightness can be reduced from the start display. This allows you to return from a sub-status to start display screen.
	Navigation keys for moving the cursor horizontally or vertically and/or change of sub-status. Modify the numerical data that need to be adjusted.
	Numerical and/or selection validation function.
	Function that will depend on the particular configuration. Where applicable, this will be explained in the relevant section. On the main screen this enables you to enter the active connections status. To exit this status, press this key again.
	Function that will depend on the particular configuration. Where applicable, this will be explained in the relevant section.

4. Modes of operation

The unit can operate in two operating modes in which the reactivation battery RB power output is managed differently.

The unit's drying capacity is controlled by managing the reactivation battery RB. (See installation and maintenance manual)

There follows an explanation of the unit's operating modes:

4.1 Manual mode

If manual mode (MAN) is selected, the fan motors, speed reducer motor that turns the rotor and the reactivation battery will start up immediately at 100% of their power output.

If the equipment has additional batteries, you must enter the required set points in the settings menu for proper operation.

4.2 Automatic mode

In automatic mode (AUTO) the start-up of the fan motors and the speed reducer motor depends on the H1 interlock and the operation of the reactivation battery is contingent on the configuration of the control and interlock H2.

There are three control configuration types for the operational management of the reactivation battery RB.

- **Configuration by stages "S"**

By means of two external digital signals, the reactivation battery is controlled with two interlocks: H2 and H3. Each stage delivers an adjustable percentage of power.

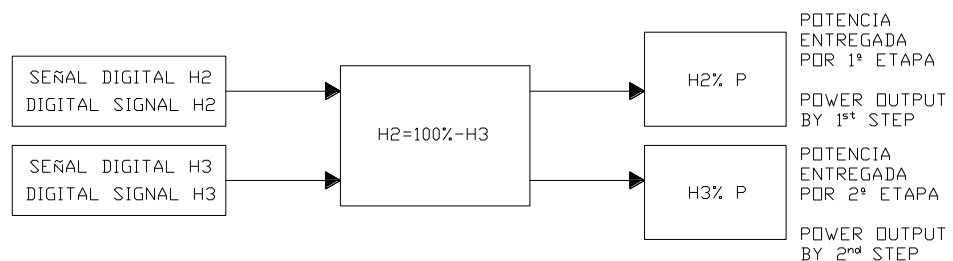

P	0%	%	%	100%
H2				
H3				

❖ Functionalities of the Hn interlocks in configuration by stages "S".

- Interlock H1 (Terminals 24-27): ON/OFF remote ventilation and rotor connection.
- Interlock H2 (Terminals 24-28): Connection of the RB first phase Requires connection H1.
- Interlock H3 (Terminals 24-29) Connection of the RB second phase.

• **Proportional Configuration "P":**

By means of an external regulated analogue signal 0...10V DC from a humidity controller/regulator a power output of 0...100% is obtained, supplied by the reactivation battery RB.

This signal must be connected to the terminals 0A-A1. (See the associated electrical diagram).

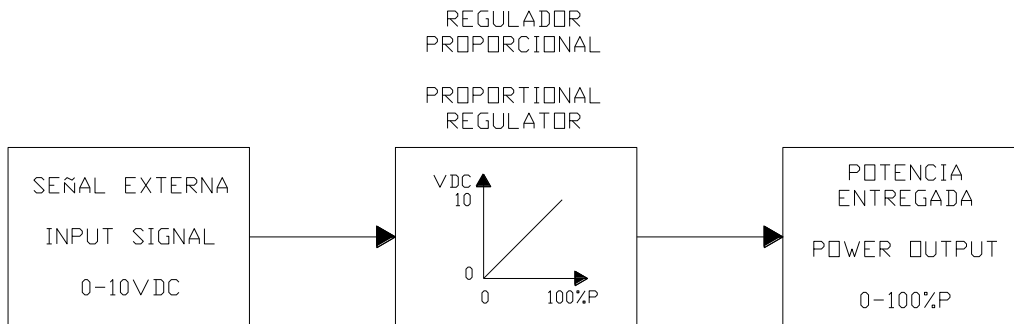

❖ Functionalities of the Hn interlocks in proportional configuration "P".

- Interlock H1 (Terminals 24-27): ON/OFF remote ventilation and rotor connection.
- Interlock H2 (Terminals 24-28): Reactivation battery ON/OFF connection. Requires connection H1.
- Interlock H3 (Terminals 24-29) Not applicable in configuration "P".

- **Configuration by Measurement signal "M":**

Using the humidity probe SH1, the PLR regulates the power delivered by the reactivation battery BR to reach the established set point.

The applicable humidity ranges for the probe to be connected are as follows:

- Relative humidity (RH): [0...100%] // [0...10V DC]
- Absolute humidity (Hx): [0...20g/kg] // [0...10V DC]
- Dew point (Tdp): [-60...+40°C] // [0...10V DC]

The SH1 probe must be connected to the X1:0A-A2 terminals. (See the associated electrical diagram).

The required humidity set point and the differential for the maximum permissible humidity alarm are entered in the settings menu (AJUS) under HR/Hx/Tdp.

The humidity alarm will be visible and will flash on the main screen when the value measured by the SH1 probe is higher than the sum total of the setpoint and the humidity alarm.

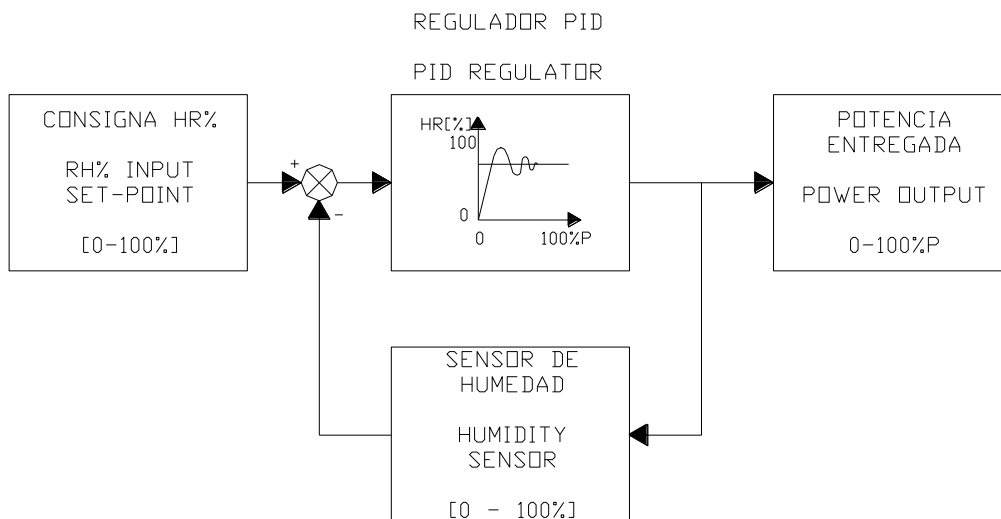

- ❖ Functionalities of the Hn interlocks in proportional configuration "P".

- Interlock H1 (Terminals 24-27): ON/OFF remote ventilation and rotor connection.
- Interlock H2 (Terminals 24-28): Reactivation battery RB ON/OFF connection. Requires connection H1.
- Interlock H3 (Terminals 24-29) Not applicable in configuration "M".

4.3 Control of additional batteries

The control of the additional batteries is independent of the selected working mode, manual or automatic. At all times:

- **Pre-heating battery control BC1:**

Using the temperature probe ST0, the PLR regulates the power delivered by the pre-heating battery BC1 to reach the set point.

The temperature probe must be connected to terminals regarding the associated electrical diagram.

The desired temperature set point is entered in the settings menu (AJUS) under T0.

The temperature range of the probe to be connected must be [-35°C...+35°C] // [0...10V DC].

- **Pre-cooling battery control BF1:**

Using the temperature probe ST3, the PLR regulates the power delivered by the pre-cooling battery BF1 to reach the set point.

The temperature probe must be connected to terminals regarding the associated electrical diagram. As a general rule, the ST3 probe is installed in the BF1 and connected according to factory settings.

The desired temperature set point is entered in the settings menu (AJUS) under T3.

The temperature range of the probe to be connected must be [0°C...+50°C] // [0...10V DC].

- **Post-cooling battery BF2 and post-heating battery BC2 control:**

Using the temperature probe ST4, the PLR regulates the power delivered by the post-cooling battery BF2 and post-heating battery BC2 to reach the adjusted set point.

The combined probe SH2-ST4 must be installed in the dry air supply.

The desired temperature set point is entered in the settings menu (AJUS) under T4.

The temperature range of the probe to be connected must be [0°C...+50°C] // [0...10V DC].

- ❖ Functionalities of the H4 interlock:

- Interlock H4 (Terminals 24-30): ON/OFF remote post-heating battery BC2 connection, no matter the chosen configuration.

5. Initial state

Having fulfilled the conditions for installation, checked that the network values match those required for the machine and having made all of the electrical connections in accordance with the control application:

Arm the switch (I1), and the following will appear on the control panel:



Initial state OK.

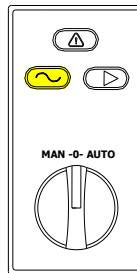

Signalling card SEF-008

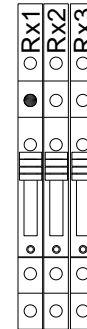

Remote signalling card SEF-013



Initial state NOT OK.

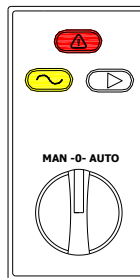

Signalling card SEF-008

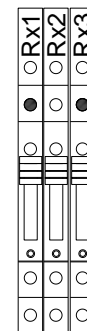

Remote signalling card SEF-013

On the signalling card SEF-008  lights up yellow, indicating that the unit is "live".

If there is any alarm/defect/fault in the unit,  will also light up red, indicating "warning".

When the unit is switched on,  lights up green, which indicates that the unit is "running".

WARNING!!! Do not switch on the unit without first reading sections 5.1 and 5.2.



The unit has a remote signalling card SEF-013 with three relays (NC-NA) with which we can obtain these remote status signals. This card is located inside the unit's electrical board, in connection block X1.

- Rx1. Remote relay indicating "unit is live"
- Rx2. Remote relay indicating "running"
- Rx3. Remote relay indicating "defect/alarm"

See the associated electrical diagram for its electrical connection.

5.1 Configuration menu

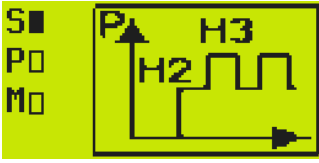
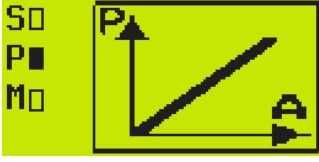
If you have chosen to operate in automatic mode, you must select from the configuration menu (CONF) one of the three pre-set configurations for operating the dehumidifier.

	<p>For detailed information on the configurations, see section 4.2.</p>
	<p>Selection of "S" stages configuration.</p>
	<p>Selection of "P" proportional configuration.</p>
	<p>Selection of configuration by measurement signal "M".</p>
	<p>Press from one of the previous screens (configuration selection) to access this screen.</p> <p>The password is obtained from the equipment electrical wiring number. For example: The password is 08514 for the equipment with the diagram number E8514.</p>

<p>√Flow •Pressure</p>	<p>On this screen, you can select the dry air blower control mode. NB. If you change the control mode, you must change the differential pressure transmitter SQ1 air intakes. Refer to the DFRA Series User Manual, section 9.9, for a detailed explanation.</p> <p>The default control mode is Flow, with the SQ1 air intakes being available for this control type. After following the steps in the User Manual to measure the pressure, you can change the control mode in this menu.</p> <p>In case of having standard or boosted fan, adjust the flow through the loss of pressure as described in section 9.9 of the user manual (MUSA).</p>
<p>√LOCAL •REMOTO</p>	<p>In dehumidifiers with Gateway for communication, you can select local or remote configuration for control:</p> <ul style="list-style-type: none"> -Local: Accepts local commissioning commands and the instructions entered in the interface screens. -Remote: Accepts start-up orders and instructions through the transmission of data through the communication bus.





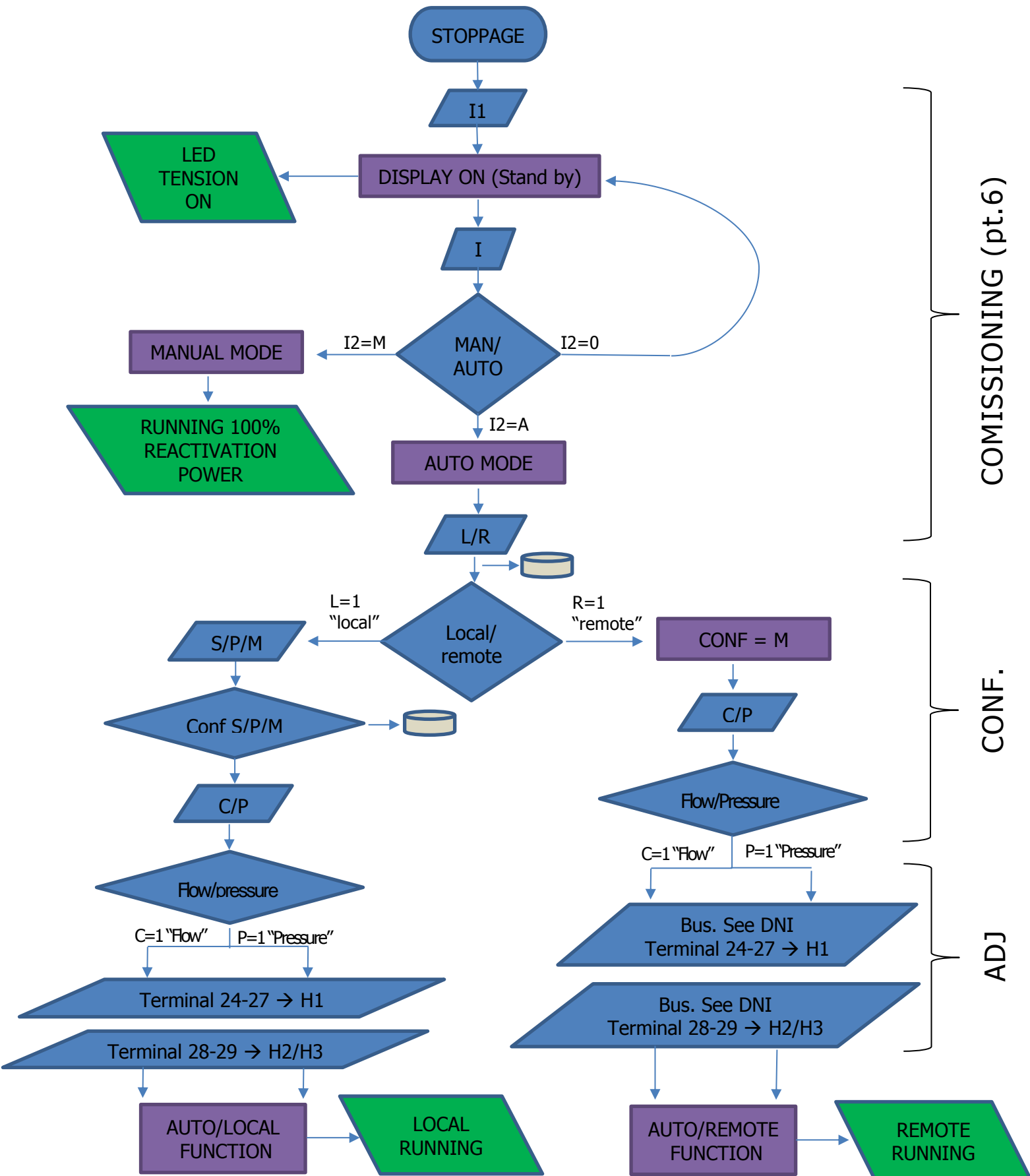



In "diagram 1" the operation of the machine is shown in summary.

Diagram 1: Mode selection process

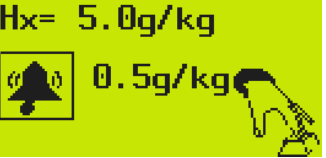
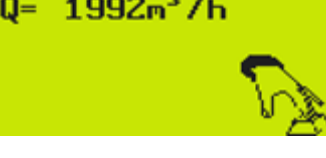
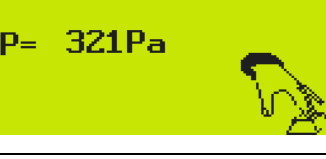

5.2 Adjustments menu

In the adjustments menu (AJUS) you must enter the required setpoint values according to the operating mode and configuration selected.

	<p>In this menu, the configuration setpoints and additional batteries are adjusted.</p> <p>Press OK to enter the menu. Using the keys  and  you can navigate through the menu screens. Press OK if you want to change a setpoint. When the digit flashes, adjust its value with the keys  and ; and with the key ESC you can return to this screen.</p>
	<p>Applicable in "S" stages configuration</p> <p>The reactivation battery is controlled with the interlocks H2 and H3 in two stages.</p> <p>In H3 the desired second stage power percentage is adjusted; hence. the first stage percentage is: $H2 = 100\% - H3$</p>
	<p>Applicable in measurement signal configuration "M":</p> <p>Setting the desired humidity set point. Enter the differential margin for maximum humidity alarm next to the icon.</p> <p>The alarm is tripped in the main synoptic when the value measured by the humidity probe SH1 is higher than the sum total of the humidity setpoint and the derential margin for maximum humidity alarm.</p>
 	<p>If the dry air blower control mode selected is the Flow mode, select the desired Q value.</p> <p>If you have selected Pressure mode, adjust the desired P value.</p>
	<p>Applies if the equipment has additional batteries</p> <p>In T0, the desired temperature is set for the pre-heating battery BC1. In T3, the desired temperature is set for the pre-cooling battery BF1. In T4, the desired temperature for dry air control is set by means of the post-cooling BF2 and post-heating BC2 batteries.</p>

6. Commissioning

Once the I1 break switch has been armed, the setpoints have been entered in the adjustments menu and the configuration has been selected (in AUTO mode only), toggle the I2 switch in the required position.

6.1 Manual mode selection

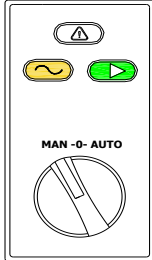
	<p>For detailed information on operation in manual mode, see section 4.1.</p>
---	---



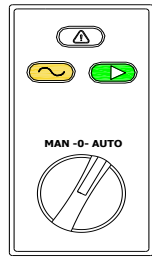

6.2 Automatic mode selection

	<p>For detailed information on operation in automatic mode, see section 4.2.</p>
--	--

6.3 Shutdown

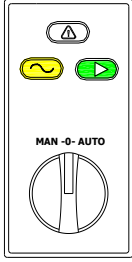
To stop the device manually, set switch I2 to position 0.

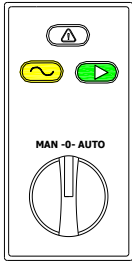
The PLR is programmed to include an operation delay on the reactivation fan and the speed reducer motor for 5 minutes to dissipate the heat from the reactivation battery, preventing its thermostatic protection from being triggered or any overheating due to radiation.

	<p>The reactivation fan and the rotor will continue to work for 5 more minutes to dissipate the heat.</p>	
	<p>If the equipment incorporates a post-heating battery BC2:</p> <p>The operating delay also extends to the process fan.</p>	

6.4 Emergency stop

In the case of a serious defect that could cause personal injuries or irreparable damage to the unit, the electric power supply must be cut off using the cut-off switch I1.



WARNING!!! Under no circumstances must the I1 cut-off switch be used for a controlled shut-down. This could damage components of the machine and affect its programming.

It must be born in mind that the 5 minutes' delay of the fan shut-down and speed reducer motor are eliminated to cool the unit down.

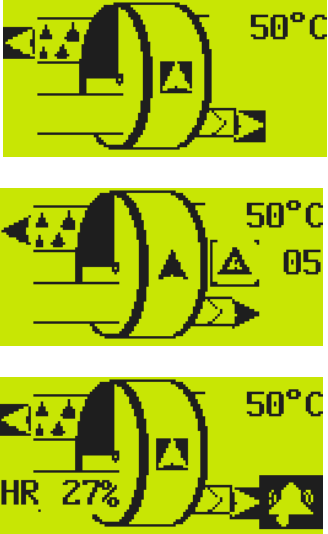

7. Supervision menu

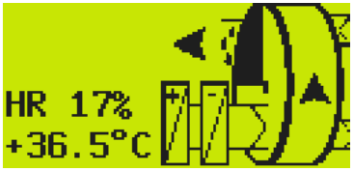
	<p>Menu displaying the operation of the main components, the temperature and humidity values and the unit's incidents or alarms on the main screen.</p>
	<p>This is the main pre-set screen.</p> <p>It activates automatically after 60 seconds have elapsed.</p> <p>The flashing arrows indicate the operation of the process (dry air) fan motor, of the speed reducer motor (rotor spin) and of the reactivation fan motor (moist air). The reactivation battery temperature measured by the ST1 probe appears in the top right corner of the screen.</p> <p>In the event of an incident or alert in the unit, a warning triangle will appear, followed by the name or number of the alert. For the alarm origin and the recommended action, see section "List of equipment alarms".</p> <p>In "M" measurement signal configuration and on the main screen, the value measured by the relative humidity probe will also appear.</p> <p>If the value measured by the probe is higher than the sum total of the set point and the alarm entered in the adjustments menu, a bell-shaped icon will flash on the screen (maximum humidity alert).</p>

With the key  navigating to the left of the main screen:

	<p>In Configuration by Measurement signal "M":</p> <p>It is displayed the relative humidity measured by probe SH1 and the temperature measured by probe ST2.</p>
	<p>This screen monitors the percentage power delivered by the pre-heating battery BC1. If the battery is working, the valve symbol twinkles.</p> <p>The displayed temperature is measured by the ST0 probe to control BF1.</p>
	<p>This screen monitors the percentage power delivered by the pre-cooling battery BF1. If the battery is working, the valve symbol twinkles.</p> <p>The displayed temperature is measured by the ST3 probe to control BF1.</p>

With the key  navigating to the right of the main screen:

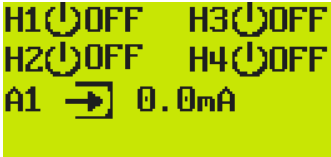
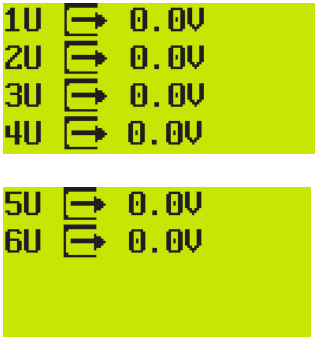
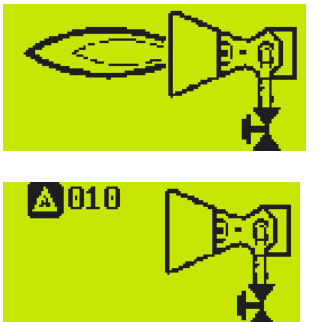
	<p>On this screen are displayed: the temperature measured by the ST3 probe and, if automatic mode has been selected, the percentage of the power supplied by the reactivation battery BR.</p> <p>If manual mode has been selected, the percentage will not appear, as it is always 100%.</p>
	<p>The humidity values SH2 and temperature ST4 from the combined probe to be installed in the dry air outlet are displayed.</p> <p>The dry air flow rate is also shown. If the pressure control is selected in the AJUS menu, the pressure value will be seen in Pascals.</p>
	<p>This screen displays the status of the H1, H2, H3 and H4 interlocks.</p> <p>If proportional configuration has been selected, the value of the external analogue signals (A1...) can be displayed on the screen.</p>
	<p>1U...6U show the output values of the output analogue signals applied to each battery (see wiring diagram).</p>
	<p>Optionally, if the dehumidifier has a gas burner reactivation heater, it will be possible to visualize the on or off state, represented by a flame.</p> <p>If the flame monitoring system detects a defect in the ignition sequence or during operation, it will be represented by an alarm icon and an error code.</p>

8. Information menu.

	<p>The information menu (INF) has counters of hours of operation of the main components to assist in maintenance guidelines.</p> <p>M1: Process air fan motor. M2: Reactivation air fan motor. M3: Rotor spin speed reducer motor. BR: Reactivation battery</p> <p>These values cannot be re-set.</p>
---	---





9. List of alerts.

Alert	Component involved	Possible causes	Recommended actions
Δ ST1	Temperature probe ST1 Temperature converter	F9 fuse blown; inverter damaged, incorrect configuration or connection of the inverter; damaged ST1 probe or incorrect connection	Check connections and if necessary replace components.
Δ 01	Process air filter pressure switch P1 (on request)	Clogged filter	Clean or replace filter.
Δ 04	Reactivation air filter pressure switch P2 (on request)	Clogged filter	Clean or replace filter.
Δ 05	Protections U1, U2, U3, F1, F2, F3...	Circuit breaker tripped	Check currents absorbed by motors and resistances with the calibres of the protections
Δ 06	Spin detector	Spin detector damaged; speed reducer motor damaged; bad connection or fuses/condensers blown; tightening belt broken or slipping.	Check that the rotor is turning, check the proximity of the rotor spin detector, check speed reducer motor fuses or condensers.
Δ 09	Safety pressure switch P0	Reactivation air flow is too low	Check air flow and components involved in the reactivation zone (fan, flaps, filters. etc.).
Δ 10	Reactivation heater by gas burner	See particular document according to burner model switchboard	According to the fault code shown in the flame monitoring control unit

Δ 19	The presence of this fault is temporary (10 s). After this time, the electric heater line circuit breaker will trip, after which the fault will be shown [05]		
	Solid state relay SSR operation protection.	Fault reported from the SSR electronic control. (See Datasheet according to reference).	Solid state relay SSR operation protection.
	Contacts or temperature probe ST1.	Electro-mechanical fault of the contacts K1, K2, K3,... or maximum reactivation temperature exceeded (160°C).	To deactivate the alarm press  .
	Safety thermostat TS open.	Excessive reactivation air temperature .	Correction: Reset mechanical thermostat (TS).
Δ 114	PLR modules	Defect in communication and/or connection among the PLR modules	Check the part and connection pins among the modules Check the power to modules.
Δ 115	Fault in PLR outlets Q1 to Q4	Short-circuit or overload in a PLR Q outlet.	Check the components connected to the outlet or replace the unit.
Δ 116	Fault in PLR outlets Q5 to Q8	Short-circuit or overload in a PLR Q outlet.	Check the components connected to the outlet or replace the unit.
Δ 26	Solid-state relay SSR2 of the post-heating battery	The SSR2 relay is not available	Check the upstream arming protection of the relay F2.

10. PLR connections status

Real-time information menu of the PLR digital inputs and outputs. The electrical schematics and these screens are very useful for troubleshooting and resolving problems.

<pre> I 12...6...10.. RE I DC P VI 13:15 Q ...4.... RUN R ..34.67..... RS I DC P VI 13:15 S 123..... RUN </pre>	<p>If the equipment has only one control unit, recognised in the electric schematic as ID1:</p> <p>Clicking on  from any screen we can access the menu "Connections status", which shows the status of the intakes I, R and outlets Q, S in real time, the day of the week and time, and the program status (RUN or STOP)</p> <p>To leave the menu and return to the screens, click on</p>
<pre> I 12.....10.. RE I NT1 GW P MI 13:20 Q .234.... RUN ZR..... RS I NT2 GW MI 13:20 ZS..... RUN </pre>	<p>If the equipment has two control units, recognised in the electric schematic as ID1 and ID2:</p> <p>Pressing  from any screen accesses the "Connection Status" menu, which shows the status of inputs I and outputs Q of the control unit ID1 = NT1 in real time: day, time and programme status (RUN or STOP).</p> <p>Clicking on  we access the status of the connections of unit ID2 = NT2.</p> <p>To leave the menu and return to the screens, click on </p>